

## General Description

The LTC881x family of single-, dual-, and quad- channel amplifiers features a maximized ratio of gain bandwidth (GBW) to supply current and is ideal for battery-powered applications such as portable instrumentations, portable medical equipments, wearable fitness devices, and wireless remote sensors. Featuring rail-to-rail input and output swings, 15-kHz bandwidth of combined with ultra-low supply current (typical 600 nA at 5.0 V per amplifier) and low noise (6.3  $\mu\text{V}_{\text{p-p}}$  at 0.1 to 10 Hz), the LTC881x family is an excellent choice for precision, cost-optimized, "Always ON" sensing applications.

The robust design of the LTC881x amplifiers provides ease-of-use to the circuit designer: integrated RF/EMI rejection filter, no phase reversal in overdrive conditions, and high electro-static discharge (ESD) protection (5-kV HBM). The LTC881x amplifiers are optimized for operation at voltages as low as +1.7 V ( $\pm 0.85$  V) and up to +5.5 V ( $\pm 2.75$  V) over the extended temperature range of  $-40^\circ\text{C}$  to  $+85^\circ\text{C}$ .

The LTC8811/3 (single) is available in both SOT23-5L and SC70-5L packages. The LTC8812 (dual) is offered in DFN-8L, SOIC-8L and MSOP-8L packages. The quad-channel LTC8814 is offered in QFN-16L, SOIC-14L and TSSOP-14L packages.

## Features and Benefits

- Ultra-Low Power Preserves Battery Life
  - 600 nA Supply Current (Typically at 5 V) Per Amplifier
- Single 1.7 V to 5.5 V Supply Voltage Range
  - Can be Powered From the Same 1.8V/2.5V/3.3V/5V System Rails
- 15 kHz GBW
- Precision Specifications for Buffer/Filter/Gain Stages
  - Low Input Offset Voltage: 0.6 mV
  - Low Noise: 6.3  $\mu\text{V}_{\text{p-p}}$  at 0.1 to 10 Hz
  - 1 pA Input Bias Current
  - Rail-to-Rail Input and Output
- Extended Temperature Range:  $-40^\circ\text{C}$  to  $+85^\circ\text{C}$

## Applications

- Battery-Powered Instruments:
  - Consumer, Industrial, Medical, Notebooks
- Wearable Fitness Devices
- Sensor Signal Conditioning:
  - Sensor Interfaces, Loop-Powered, Active Filters
- Wireless Sensors:
  - Home Security, Remote Sensing, Wireless Metering

## Pin Configurations (Top View)

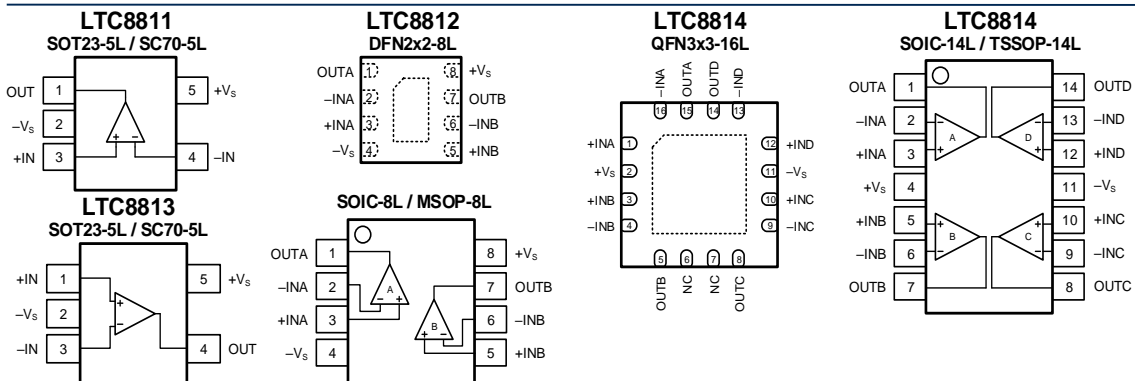

CAUTION: These devices are sensitive to electrostatic discharge; follow proper IC Handling Procedures.  
 Linearin and designs are registered trademarks of Linearin Technology Corporation.  
 © Copyright Linearin Technology Corporation. All Rights Reserved.  
 All other trademarks mentioned are the property of their respective owners.

## Pin Description

Symbol	Description
-IN	Inverting input of the amplifier.
+IN	Non-inverting input of the amplifier.
+V <sub>S</sub>	Positive (highest) power supply.
-V <sub>S</sub>	Negative (lowest) power supply.
OUT	Amplifier output.

## Ordering Information

Type Number	Package Name	Package Quantity	Marking Code
LTC8811YT5/R6	SOT23-5L	Tape and Reel, 3 000	AN1
LTC8811YC5/R6	SC70-5L	Tape and Reel, 3 000	AN1
LTC8812YF8/R6	DFN2x2-8L	Tape and Reel, 3 000	AN2
LTC8812YS8/R8	SOIC-8L	Tape and Reel, 4 000	AN2 Y
LTC8812YV8/R6	MSOP-8L	Tape and Reel, 3 000	AN2Y
LTC8813YT5/R6	SOT23-5L	Tape and Reel, 3 000	AN3
LTC8813YC5/R6	SC70-5L	Tape and Reel, 3 000	AN3
LTC8814YS14/R5	SOIC-14L	Tape and Reel, 2 500	AN4 Y
LTC8814XF16/R6	QFN3x3-16L	Tape and Reel, 3 000	AN4 Y
LTC8814YT14/R6	TSSOP-14L	Tape and Reel, 3 000	AN4 Y

## Limiting Value

In accordance with the Absolute Maximum Rating System (IEC 60134).

Parameter	Absolute Maximum Rating
Supply Voltage, V <sub>S+</sub> to V <sub>S-</sub>	10.0 V
Signal Input Terminals: Voltage, Current	V <sub>S-</sub> - 0.5 V to V <sub>S+</sub> + 0.5 V, ±10 mA
Output Short-Circuit	Continuous
Storage Temperature Range, T <sub>stg</sub>	-65 °C to +150 °C
Junction Temperature, T <sub>J</sub>	150 °C
Lead Temperature Range (Soldering 10 sec)	260 °C

## ESD Rating

Parameter	Item	Value	Unit
Electrostatic Discharge Voltage	Human body model (HBM), per MIL-STD-883J / Method 3015.9 <sup>(1)</sup>	± 5 000	V
	Charged device model (CDM), per ESDA/JEDEC JS-002-2014 <sup>(2)</sup>	± 2 000	
	Machine model (MM), per JESD22-A115C	± 250	

(1) JEDEC document JEP155 states that 500-V HBM allows safe manufacturing with a standard ESD control process.

(2) JEDEC document JEP157 states that 250-V CDM allows safe manufacturing with a standard ESD control process.

## Electrical Characteristics

$V_S = 5.0V$ ,  $T_A = +25^\circ C$ ,  $V_{CM} = V_S/2$ ,  $V_O = V_S/2$ , and  $R_L = 10k\Omega$  connected to  $V_S/2$ , unless otherwise noted.

**Boldface limits apply over the specified temperature range,  $T_A = -40$  to  $+85^\circ C$ .**

Symbol	Parameter	Conditions	Min.	Typ.	Max.	Unit
<b>OFFSET VOLTAGE</b>						
$V_{OS}$	Input offset voltage			$\pm 0.6$	$\pm 3.0$	mV
$V_{OS\ TC}$	Offset voltage drift	$T_A = -40$ to $+85^\circ C$		$\pm 1$	$\pm 3$	$\mu V/^\circ C$
PSRR	Power supply rejection ratio	$V_S = 1.7$ to $5.5$ V, $V_{CM} < V_{S+} - 2$ V	76	92		dB
		$T_A = -40$ to $+85^\circ C$	<b>72</b>			
<b>INPUT BIAS CURRENT</b>						
$I_B$	Input bias current			1		pA
		$T_A = +85^\circ C$		150		
$I_{OS}$	Input offset current			5		pA
<b>NOISE</b>						
$V_n$	Input voltage noise	$f = 0.1$ to $10$ Hz		6.3		$\mu V_{P-P}$
$e_n$	Input voltage noise density	$f = 1$ kHz		177		nV/ $\sqrt{Hz}$
		$f = 100$ Hz		184		
$I_n$	Input current noise density	$f = 1$ kHz		10		fA/ $\sqrt{Hz}$
<b>INPUT VOLTAGE</b>						
$V_{CM}$	Common-mode voltage range		$V_{S-} - 0.1$		$V_{S+} + 0.1$	V
		$T_A = -40$ to $+85^\circ C$	$V_{S-}$		$V_{S+} - 0.1$	
CMRR	Common-mode rejection ratio	$V_S = 5.5$ V, $V_{CM} = -0.1$ to $5.5$ V	67	84		dB
		$V_{CM} = 0$ to $5.3$ V, $T_A = -40$ to $+85^\circ C$	<b>64</b>			
		$V_S = 1.8$ V, $V_{CM} = -0.1$ to $1.8$ V	65	79		
		$V_{CM} = 0$ to $1.6$ V, $T_A = -40$ to $+85^\circ C$	<b>62</b>			
<b>INPUT IMPEDANCE</b>						
$R_{IN}$	Input resistance		100			G $\Omega$
$C_{IN}$	Input capacitance	Differential		2.0		pF
		Common mode		3.5		
<b>OPEN-LOOP GAIN</b>						
$A_{VOL}$	Open-loop voltage gain	$R_L = 50$ k $\Omega$ , $V_O = 0.05$ to $3.5$ V	80	97		dB
		$T_A = -40$ to $+85^\circ C$	<b>75</b>			
		$R_L = 5$ k $\Omega$ , $V_O = 0.15$ to $3.5$ V	68	82		
		$T_A = -40$ to $+85^\circ C$	<b>64</b>			
<b>FREQUENCY RESPONSE</b>						
GBW	Gain bandwidth product			15		kHz
SR	Slew rate	$G = +1$ , $C_L = 50$ pF, $V_O = 1.5$ to $3.5$ V		6		V/ms
<b>OUTPUT</b>						
$V_{OH}$	High output voltage swing	$R_L = 50$ k $\Omega$	$V_{S+} - 7$	$V_{S+} - 4$		mV
		$R_L = 5$ k $\Omega$	$V_{S+} - 65$	$V_{S+} - 40$		
$V_{OL}$	Low output voltage swing	$R_L = 50$ k $\Omega$		$V_{S-} + 3$	$V_{S-} + 5$	mV
		$R_L = 5$ k $\Omega$		$V_{S-} + 27$	$V_{S-} + 42$	

### Electrical Characteristics (continued)

$V_S = 5.0V$ ,  $T_A = +25^\circ C$ ,  $V_{CM} = V_S/2$ ,  $V_O = V_S/2$ , and  $R_L = 10k\Omega$  connected to  $V_S/2$ , unless otherwise noted.  
**Boldface limits apply over the specified temperature range,  $T_A = -40$  to  $+85^\circ C$ .**

Symbol	Parameter	Conditions	Min.	Typ.	Max.	Unit
$I_{SC}$	Short-circuit current	Source current through $10\Omega$	20	27		mA
		Sink current through $10\Omega$		-33	-25	
<b>POWER SUPPLY</b>						
$V_S$	Operating supply voltage	$T_A = -40$ to $+85^\circ C$	1.7		5.5	V
$I_Q$	Quiescent current (per amplifier)	$V_S = 1.8V$ , $T_A = +25^\circ C$		450	650	nA
		$V_S = 5.0V$ , $T_A = +25^\circ C$		600	880	
<b>THERMAL CHARACTERISTICS</b>						
$T_A$	Operating temperature range		-40		+85	$^\circ C$
$\theta_{JA}$	Package Thermal Resistance	SC70-5L		333		$^\circ C/W$
		SOT23-5L		190		
		DFN2x2-8L		80		
		MSOP-8L		216		
		SOIC-8L		125		
		QFN3x3-16L		65		
		TSSOP-14L		112		
		SOIC-14L		115		

## Typical Performance Characteristics

At  $T_A = +25^\circ\text{C}$ ,  $V_{CM} = V_S/2$ , and  $R_L = 10\text{k}\Omega$  connected to  $V_S/2$ , unless otherwise noted.

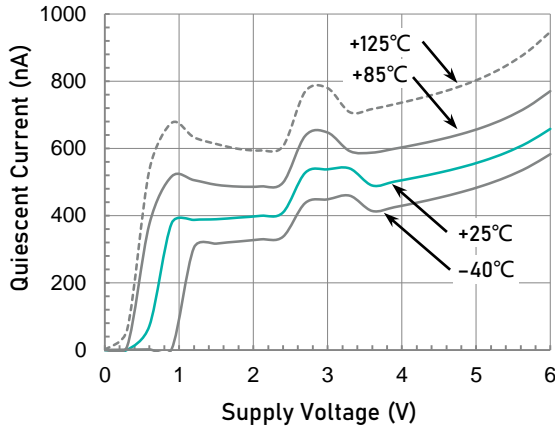

Quiescent Current as a function of Supply Voltage.

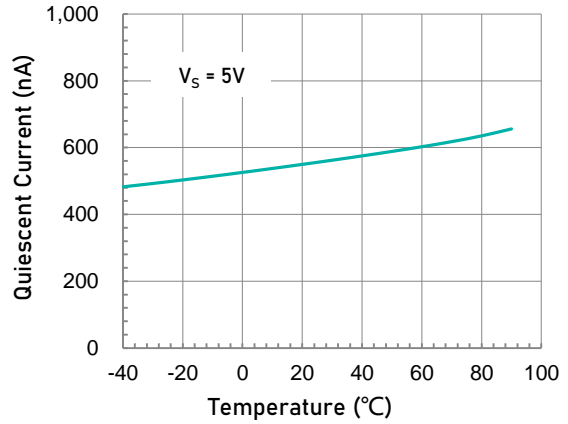

Quiescent Current as a function of Temperature.

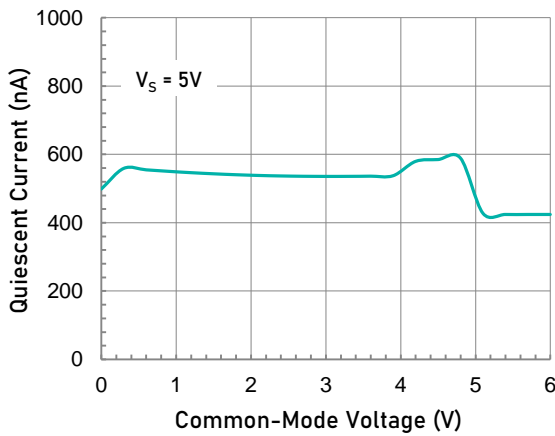

Quiescent Current as a function of Input Common-Mode Voltage.

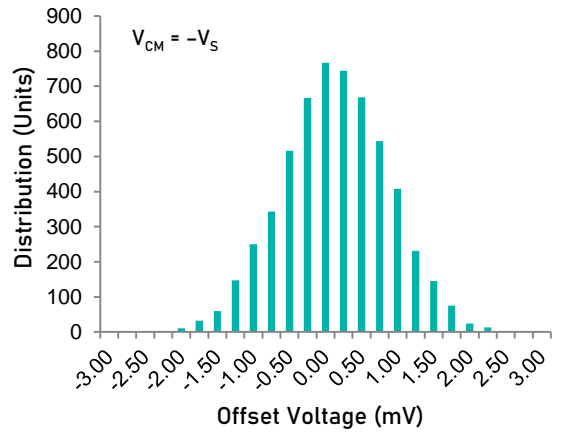

Offset Voltage Production Distribution

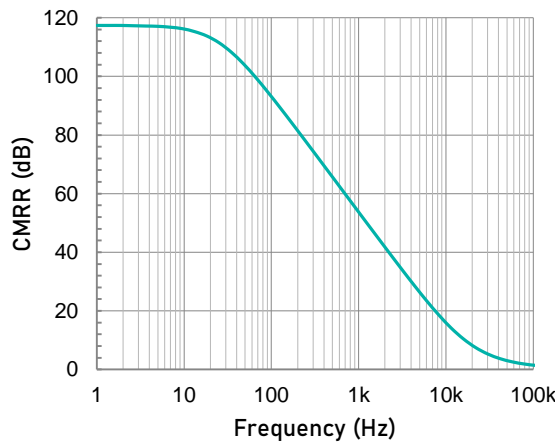

Common-mode Rejection Ratio as a function of Frequency.

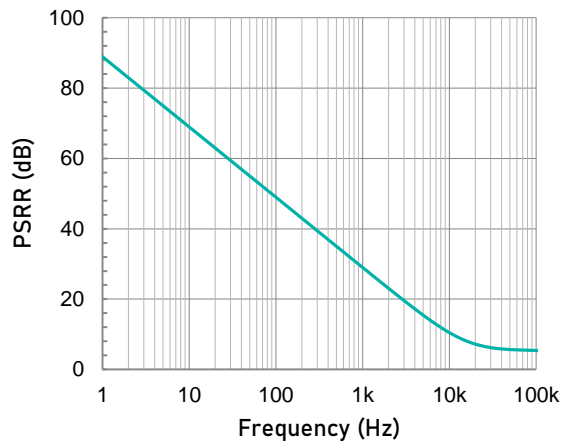

Power Supply Rejection Ratio as a function of Frequency.

CAUTION: These devices are sensitive to electrostatic discharge; follow proper IC Handling Procedures.  
 Linearin and designs are registered trademarks of Linearin Technology Corporation.  
 © Copyright Linearin Technology Corporation. All Rights Reserved.  
 All other trademarks mentioned are the property of their respective owners.

### Typical Performance Characteristics (continued)

At  $T_A = +25^\circ\text{C}$ ,  $V_{CM} = V_S/2$ , and  $R_L = 10\text{k}\Omega$  connected to  $V_S/2$ , unless otherwise noted.

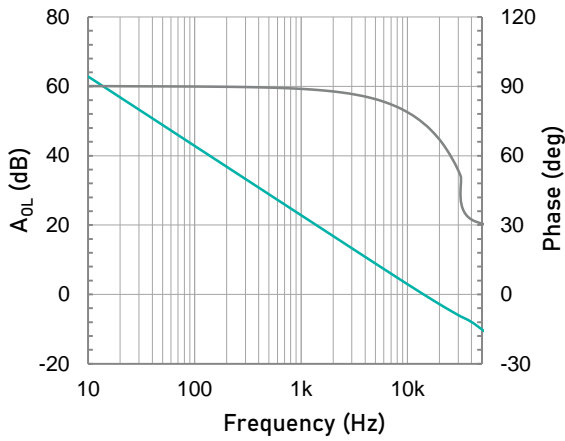

Open-loop Gain and Phase as a function of Frequency.

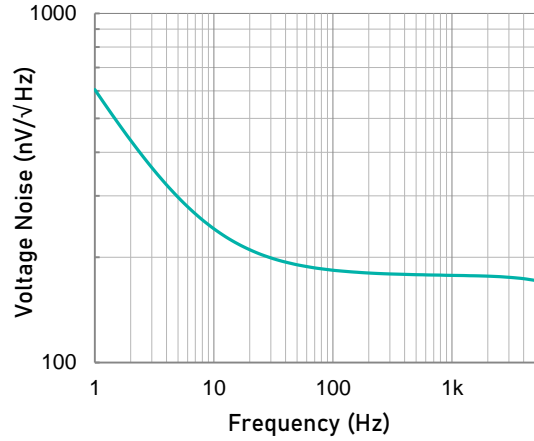

Input Voltage Noise Spectral Density as a function of Frequency.

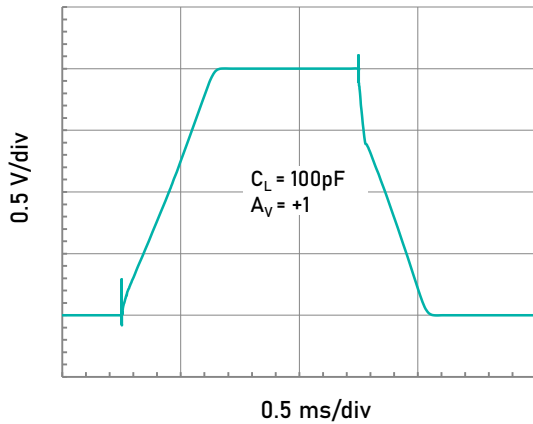

Large Signal Step Response (2V Step).

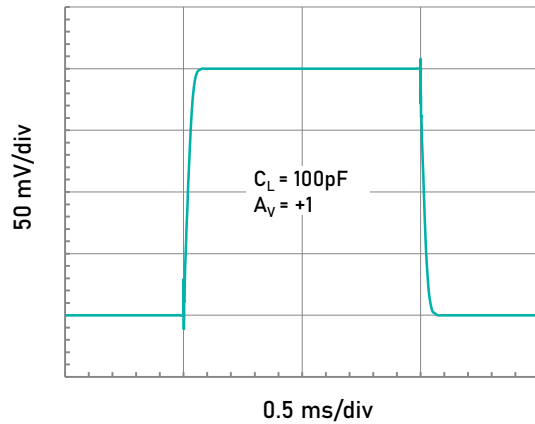

Small Signal Step Response (200mV Step).

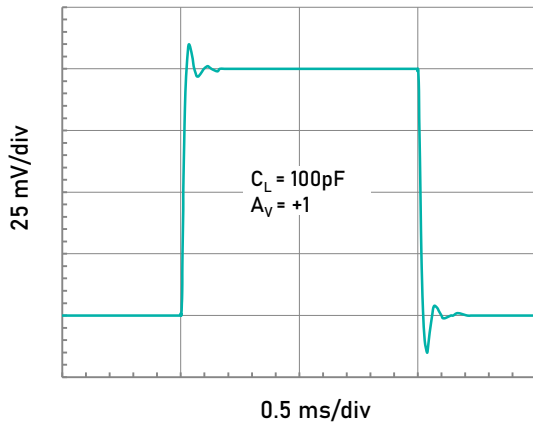

Small Signal Step Response (100mV Step).

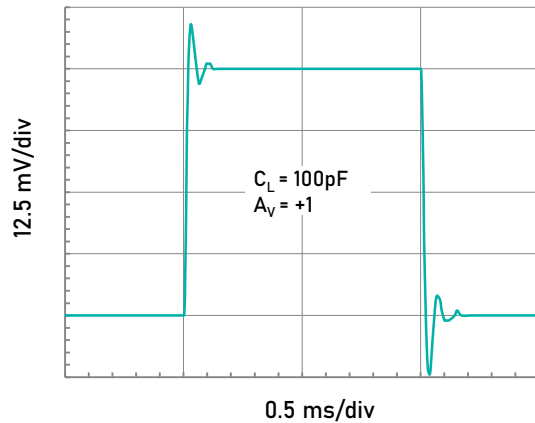

Small Signal Step Response (50mV Step).

CAUTION: These devices are sensitive to electrostatic discharge; follow proper IC Handling Procedures.  
Linearin and designs are registered trademarks of Linearin Technology Corporation.  
© Copyright Linearin Technology Corporation. All Rights Reserved.  
All other trademarks mentioned are the property of their respective owners.

### Typical Performance Characteristics (continued)

At  $T_A = +25^\circ\text{C}$ ,  $V_{CM} = V_S/2$ , and  $R_L = 10\text{k}\Omega$  connected to  $V_S/2$ , unless otherwise noted.

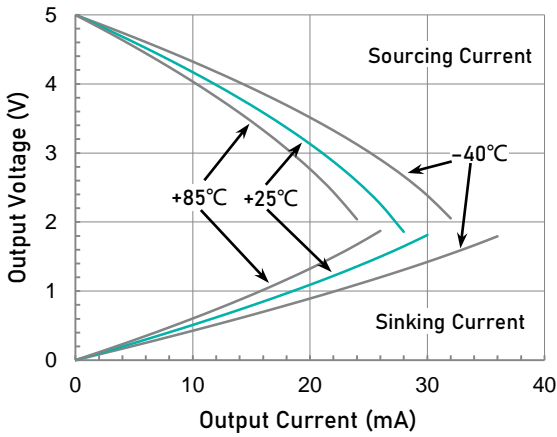

Output Voltage Swing as a function of Output Current.

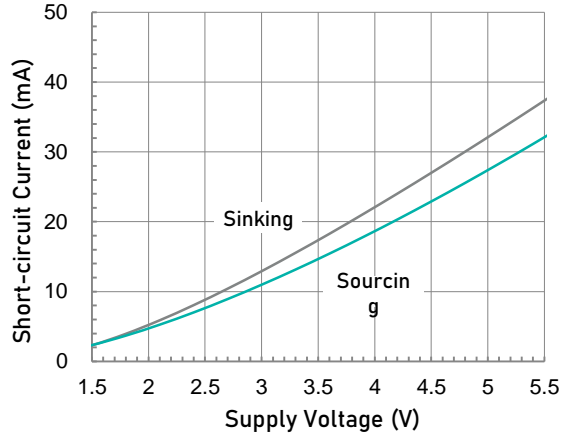

Short-circuit Current as a function of Supply Voltage.

## Application Notes

Featuring a maximized ratio of GBW-to-supply current, low operating supply voltage, low input bias current, and rail-to-rail inputs and outputs, the LTC881x family is an excellent choice for precision or general-purpose, low-current, low-voltage, battery-powered applications. These CMOS operational amplifiers consume an ultra-low 600-nA (typically at 5-V supply voltage) supply current per amplifier. The LTC881x family is unity-gain stable with a 15-kHz GBW product, driving capacitive loads up to 250-pF.

### OPERATING VOLTAGE

The LTC881x family is fully specified and ensured for operation at voltages as low as +1.7 V ( $\pm 0.85$  V) and up to +5.5 V ( $\pm 2.75$  V). In addition, many specifications apply from  $-40$  °C to +85 °C. Parameters that vary significantly with operating voltages or temperature are illustrated in the Typical Characteristics graphs.

### RAIL-TO-RAIL INPUT

The input common-mode voltage range of the LTC881x series extends 100-mV beyond the negative and positive supply rails. This performance is achieved with a complementary input stage: an N-channel input differential pair in parallel with a P-channel differential pair. The N-channel pair is active for input voltages close to the positive rail, typically  $V_{S+} - 1.4$  V to the positive supply, whereas the P-channel pair is active for inputs from 100-mV below the negative supply to approximately  $V_{S+} - 1.4$  V. There is a small transition region, typically  $V_{S+} - 1.2$  V to  $V_{S+} - 1$  V, in which both pairs are on. This 200-mV transition region can vary up to 200-mV with process variation. Thus, the transition region (both stages on) can range from  $V_{S+} - 1.4$  V to  $V_{S+} - 1.2$  V on the low end, up to  $V_{S+} - 1$  V to  $V_{S+} - 0.8$  V on the high end. Within this transition region, PSRR, CMRR, offset voltage, offset drift, and THD can be degraded compared to device operation outside this region.

The typical input bias current of the LTC881x during normal operation is approximately 1-pA. In overdriven conditions, the bias current can increase significantly. The most common cause of an overdriven condition occurs when the operational amplifier is outside of the linear range of operation. When the output of the operational amplifier is driven to one of the supply rails, the feedback loop requirements cannot be satisfied and a differential input voltage develops across the input pins. This differential input voltage results in activation of parasitic diodes inside the front-end input chopping switches that combine with electromagnetic interference (EMI) filter resistors to create the equivalent circuit. Notice that the input bias current remains within specification in the linear region.

### INPUT EMI FILTER AND CLAMP CIRCUIT

Figure 1 shows the input EMI filter and clamp circuit. The LTC881x op-amps have internal ESD protection diodes (D1, D2, D3, and D4) that are connected between the inputs and each supply rail. These diodes protect the input transistors in the event of electrostatic discharge and are reverse biased during normal operation. This protection scheme allows voltages as high as approximately 500-mV beyond the rails to be applied at the input of either terminal without causing permanent damage. These ESD protection current-steering diodes also provide in-circuit, input overdrive protection, as long as the current is limited to 10-mA as stated in the Absolute Maximum Ratings.

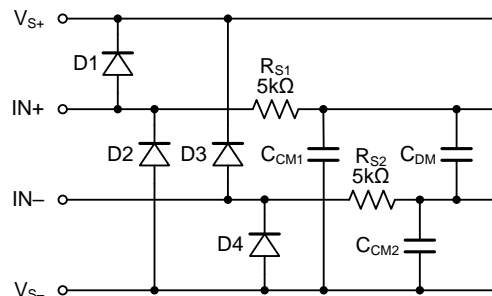

Figure 1. Input EMI Filter and Clamp Circuit

Operational amplifiers vary in susceptibility to EMI. If conducted EMI enters the operational amplifier, the dc offset at the amplifier output can shift from its nominal value when EMI is present. This shift is a result of signal rectification associated with the internal semiconductor junctions. Although all operational amplifier pin functions can be affected by EMI, the input pins are likely to be the most susceptible. The EMI filter of the LTC881x family is composed of two 5-kΩ input series resistors ( $R_{S1}$  and  $R_{S2}$ ), two common-mode capacitors ( $C_{CM1}$  and  $C_{CM2}$ ), and a differential capacitor ( $C_{DM}$ ). These RC networks set the  $-3$  dB low-pass cutoff frequencies at 35-MHz for common-mode signals, and at 22-MHz for differential signals.

### RAIL-TO-RAIL OUTPUT

Designed as a micro-power, low-noise operational amplifier, the LTC881x delivers a robust output drive capability. A class AB output stage with common-source transistors is used to achieve full rail-to-rail output swing capability. For resistive loads up to 50-kΩ, the output swings typically to within 4 mV of either supply rail regardless of the power-supply voltage applied. Different load conditions change the ability of the amplifier to swing close to the rails. For resistive loads up to 2-kΩ, the output swings typically to within 40-mV of the positive supply rail and within 27-mV of the negative supply rail.



## Application Notes (continued)

### CAPACITIVE LOAD AND STABILITY

The LTC881x family of operational amplifiers can safely drive capacitive loads of up to 250-pF in any configuration. As with most amplifiers, driving larger capacitive loads than specified may cause excessive overshoot and ringing, or even oscillation. A heavy capacitive load reduces the phase margin and causes the amplifier frequency response to peak. Peaking corresponds to overshooting or ringing in the time domain. Therefore, it is recommended that external compensation be used if the LTC881x family requires greater capacitive-drive capability. This compensation is particularly important in the unity-gain configuration, which is the worst case for stability.

A quick and easy way to stabilize the op-amp for capacitive load drive is by adding a series resistor,  $R_{ISO}$ , between the amplifier output terminal and the load capacitance, as shown in Figure 2.  $R_{ISO}$  isolates the amplifier output and feedback network from the capacitive load. The bigger the  $R_{ISO}$  resistor value, the more stable  $V_{OUT}$  will be. Note that this method results in a loss of gain accuracy because  $R_{ISO}$  forms a voltage divider with the  $R_L$ . In unity gain applications with relatively small  $R_L$  (approximately 5-k $\Omega$ ), the capacitive load can be increased up to 100-pF.

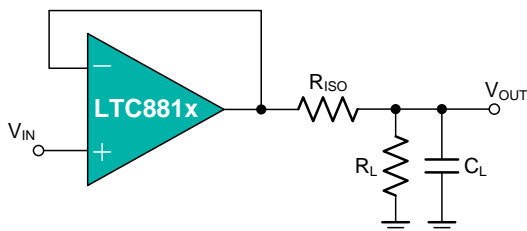

Figure 2. Indirectly Driving Heavy Capacitive Load

An improvement circuit is shown in Figure 3. It provides DC accuracy as well as AC stability. The  $R_F$  provides the DC accuracy by connecting the inverting signal with the output.

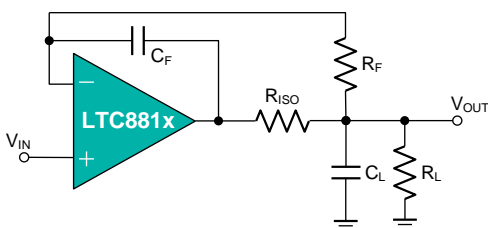

Figure 3. Indirectly Driving Heavy Capacitive Load with DC Accuracy

The  $C_F$  and  $R_{ISO}$  serve to counteract the loss of phase margin by feeding the high frequency component of the output signal back to the amplifier's inverting input, thereby preserving phase margin in the overall

feedback loop.

For no-buffer configuration, there are two others ways to increase the phase margin: (a) by increasing the amplifier's gain, or (b) by placing a capacitor in parallel with the feedback resistor to counteract the parasitic capacitance associated with inverting node.

### EMI REJECTION RATIO

Circuit performance is often adversely affected by high frequency EMI. When the signal strength is low and transmission lines are long, an op-amp must accurately amplify the input signals. However, all op-amp pins — the non-inverting input, inverting input, positive supply, negative supply, and output pins — are susceptible to EMI signals. These high frequency signals are coupled into an op-amp by various means, such as conduction, near field radiation, or far field radiation. For example, wires and printed circuit board (PCB) traces can act as antennas and pick up high frequency EMI signals.

Amplifiers do not amplify EMI or RF signals due to their relatively low bandwidth. However, due to the nonlinearities of the input devices, op-amps can rectify these out of band signals. When these high frequency signals are rectified, they appear as a dc offset at the output.

The LTC881x op-amps have integrated EMI filters at their input stage. A mathematical method of measuring EMIRR is defined as follows:

$$EMIRR = 20 \log (V_{IN\_PEAK} / \Delta V_{OS})$$

### INPUT-TO-OUTPUT COUPLING

To minimize capacitive coupling, the input and output signal traces should not be parallel. This helps reduce unwanted positive feedback.

### MAXIMIZING PERFORMANCE THROUGH PROPER LAYOUT

To achieve the maximum performance of the extremely high input impedance and low offset voltage of the LTC881x op-amps, care is needed in laying out the circuit board. The PCB surface must remain clean and free of moisture to avoid leakage currents between adjacent traces. Surface coating of the circuit board reduces surface moisture and provides a humidity barrier, reducing parasitic resistance on the board. The use of guard rings around the amplifier inputs further reduces leakage currents. Figure 4 shows proper guard ring configuration and the top view of a surface-mount layout. The guard ring does not need to be a specific width, but it should form a continuous loop around both inputs. By setting the guard ring voltage equal to the voltage at the non-inverting input, parasitic capacitance is minimized as well. For further reduction of leakage currents, components can be mounted to the PCB using Teflon standoff insulators.

## Application Notes (continued)

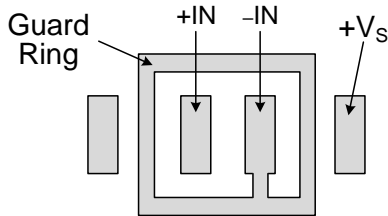

Figure 4. Use a guard ring around sensitive pins

Other potential sources of offset error are thermoelectric voltages on the circuit board. This voltage, also called Seebeck voltage, occurs at the junction of two dissimilar metals and is proportional to the temperature of the junction. The most common

metallic junctions on a circuit board are solder-to-board trace and solder-to-component lead. If the temperature of the PCB at one end of the component is different from the temperature at the other end, the resulting Seebeck voltages are not equal, resulting in a thermal voltage error.

This thermocouple error can be reduced by using dummy components to match the thermoelectric error source. Placing the dummy component as close as possible to its partner ensures both Seebeck voltages are equal, thus canceling the thermocouple error. Maintaining a constant ambient temperature on the circuit board further reduces this error. The use of a ground plane helps distribute heat throughout the board and reduces EMI noise pickup.

## Typical Application Circuits

### DIFFERENTIAL AMPLIFIER

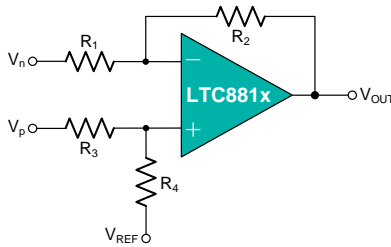
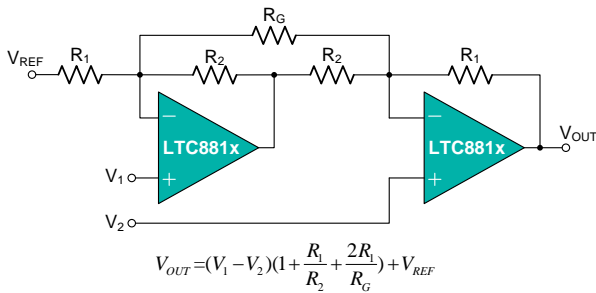

Figure 5. Differential Amplifier

The circuit shown in Figure 5 performs the difference function. If the resistors ratios are equal  $R_4/R_3 = R_2/R_1$ , then:

$$V_{OUT} = (V_p - V_n) \times R_2/R_1 + V_{REF}$$

### INSTRUMENTATION AMPLIFIER



$$V_{OUT} = (V_1 - V_2) \left( 1 + \frac{R_1}{R_2} + \frac{2R_1}{R_G} \right) + V_{REF}$$

Figure 6. Instrumentation Amplifier

The LTC881x family is well suited for conditioning sensor signals in battery-powered applications. Figure 6 shows a two op-amp instrumentation amplifier, using the LTC881x op-amps. The circuit works well for applications requiring rejection of common-mode noise at higher gains. The reference voltage ( $V_{REF}$ ) is supplied by a low-impedance source. In single voltage supply applications, the  $V_{REF}$  is typically  $V_S/2$ .

### BATTERY MONITORING

The low operating voltage and quiescent current of the LTC881x family make it an excellent choice for battery monitoring applications, as shown in Figure 7. In this circuit,  $V_{STATUS}$  is high as long as the battery voltage remains above 2-V ( $V_{REF} = 1.2V$ ). A low-power reference is used to set the trip point. Resistor values are selected as follows:

1.  $R_F$  Selecting: Select  $R_F$  such that the current through  $R_F$  is approximately 1000x larger than the maximum bias current over temperature:  
 $R_F = V_{REF} \div (1000 \times I_{BMAX}) = 1.2V \div (1000 \times 100pA) = 12M\Omega \approx 10M\Omega$
2. Choose the hysteresis voltage,  $V_{HYST}$ . For battery

monitoring applications, 50-mV is adequate.

3. Calculate  $R_1$  as follows:  
 $R_1 = R_F \times (V_{HYST} \div V_{BATT}) \approx 10M\Omega \times (50mV \div 2.4V) = 210k\Omega$
4. Select a threshold voltage for  $V_{IN}$  rising ( $V_{TS} = 2.0V$ ).
5. Calculate  $R_2$  as follows:  
 $R_2 = 1 \div [V_{TS} \div (V_{REF} \times R_1) - 1 \div R_1 - 1 \div R_F] = 1 \div [2V \div (1.2V \times 210k\Omega) - 1 \div 210k\Omega - 1 \div 10M\Omega] = 325k\Omega$
6. Calculate  $R_{BIAS}$ : The minimum supply voltage for this circuit is 1.8V. Providing 5 $\mu$ A of supply current assures proper operation. Therefore:  
 $R_{BIAS} = (V_{BATTMIN} - V_{REF}) \div I_{BIAS} = (1.8V - 1.2V) \div 5\mu A = 120k\Omega$

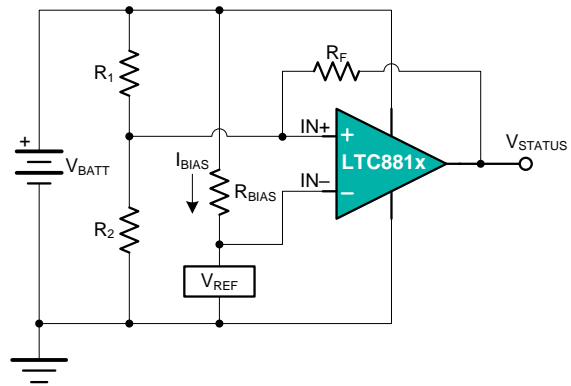

Figure 7. Battery Monitor

### PORTABLE GAS METER

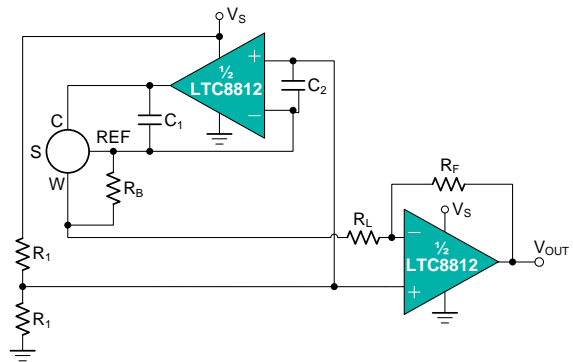
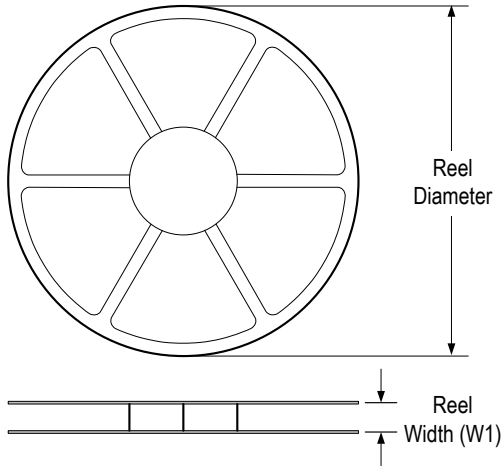

Figure 8. Portable Gas Meter Application

CAUTION: These devices are sensitive to electrostatic discharge; follow proper IC Handling Procedures. Linearin and designs are registered trademarks of Linearin Technology Corporation. © Copyright Linearin Technology Corporation. All Rights Reserved. All other trademarks mentioned are the property of their respective owners.

## Tape and Reel Information

### REEL DIMENSIONS



### TAPE DIMENSIONS

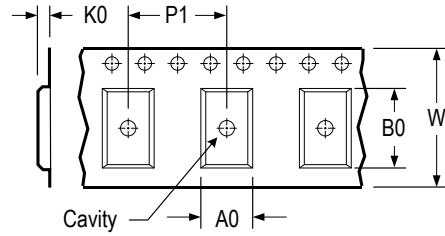

A0	Dimension designed to accommodate the component width
B0	Dimension designed to accommodate the component length
K0	Dimension designed to accommodate the component thickness
W	Overall width of the carrier tape
P1	Pitch between successive cavity centers

### QUADRANT ASSIGNMENTS FOR PIN 1 ORIENTATION IN TAPE

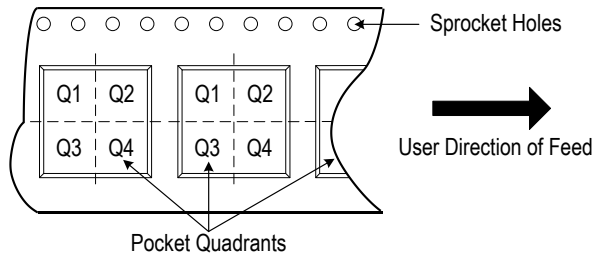

\* All dimensions are nominal

Device	Package Type	Pins	SPQ	Reel Diameter (mm)	Reel Width W1 (mm)	A0 (mm)	B0 (mm)	K0 (mm)	P1 (mm)	W (mm)	Pin 1 Quadrant
LTC8811XT5/R6	SOT23	5	3 000	178	9.0	3.3	3.2	1.5	4.0	8.0	Q3

## Package Outlines

### DIMENSIONS, SOT23-5L

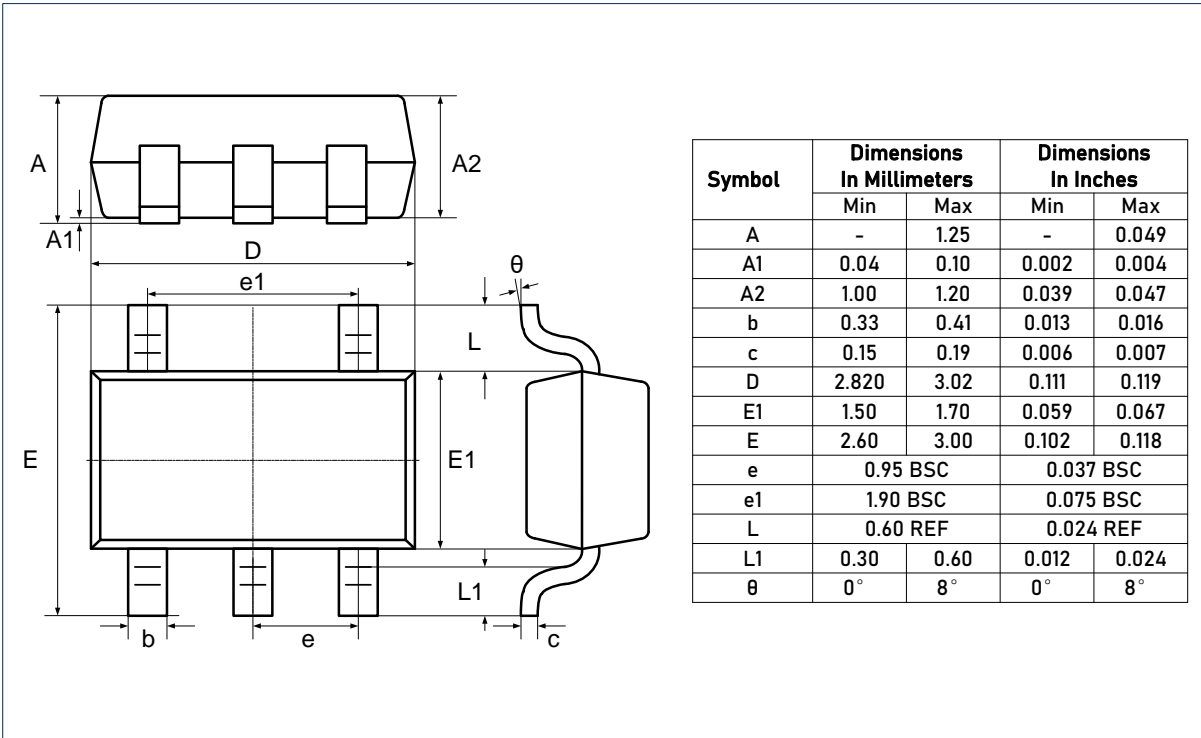

### RECOMMENDED SOLDERING FOOTPRINT, SOT23-5L

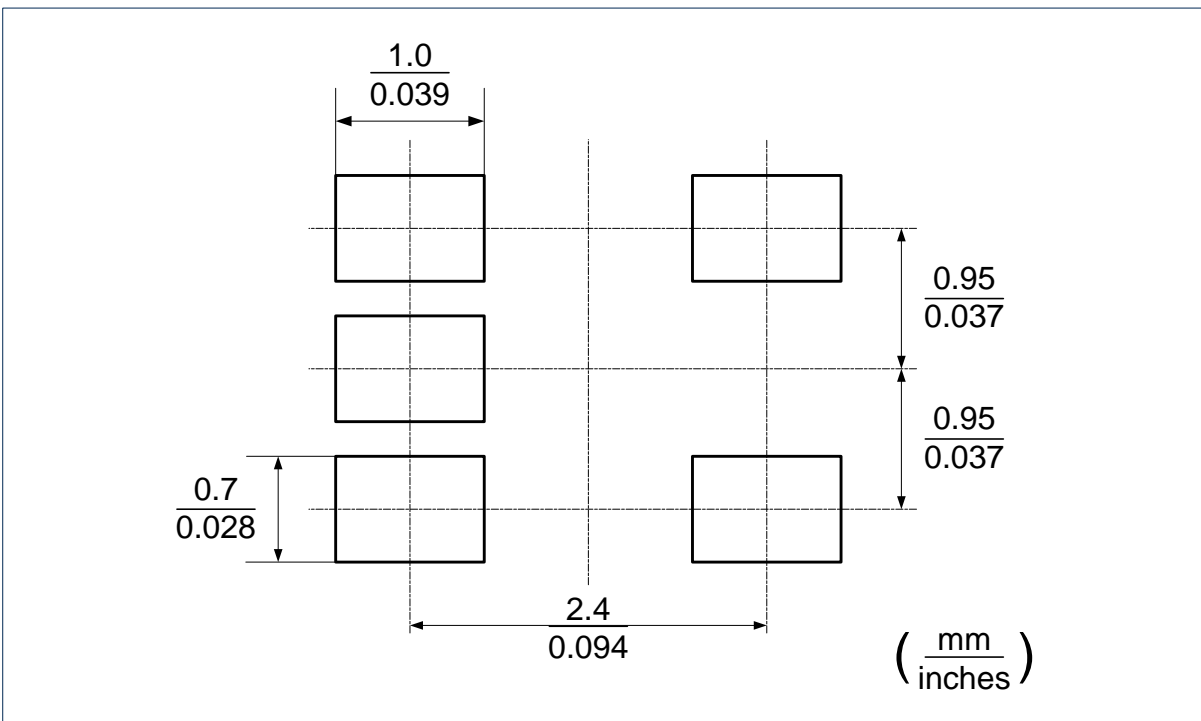

CAUTION: These devices are sensitive to electrostatic discharge; follow proper IC Handling Procedures.  
 Linearin and designs are registered trademarks of Linearin Technology Corporation.  
 © Copyright Linearin Technology Corporation. All Rights Reserved.  
 All other trademarks mentioned are the property of their respective owners.

## Package Outlines (continued)

### DIMENSIONS, SC70-5L (SOT353)

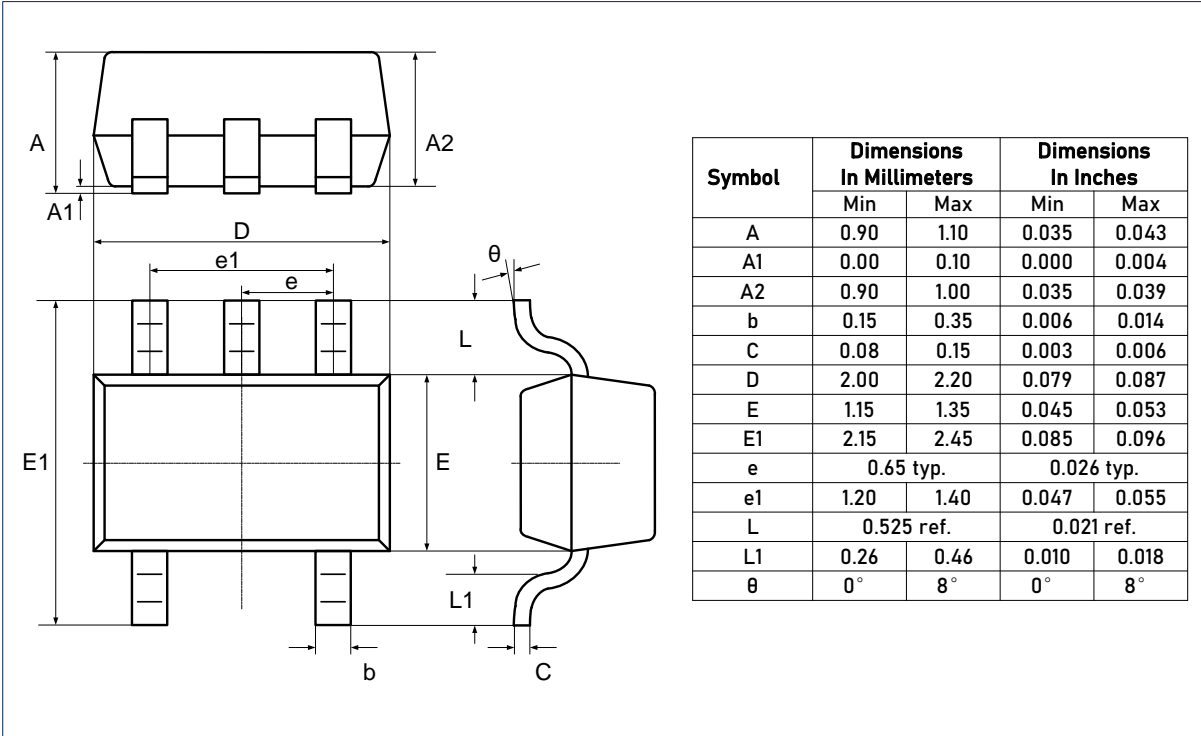

### RECOMMENDED SOLDERING FOOTPRINT, SC70-5L (SOT353)

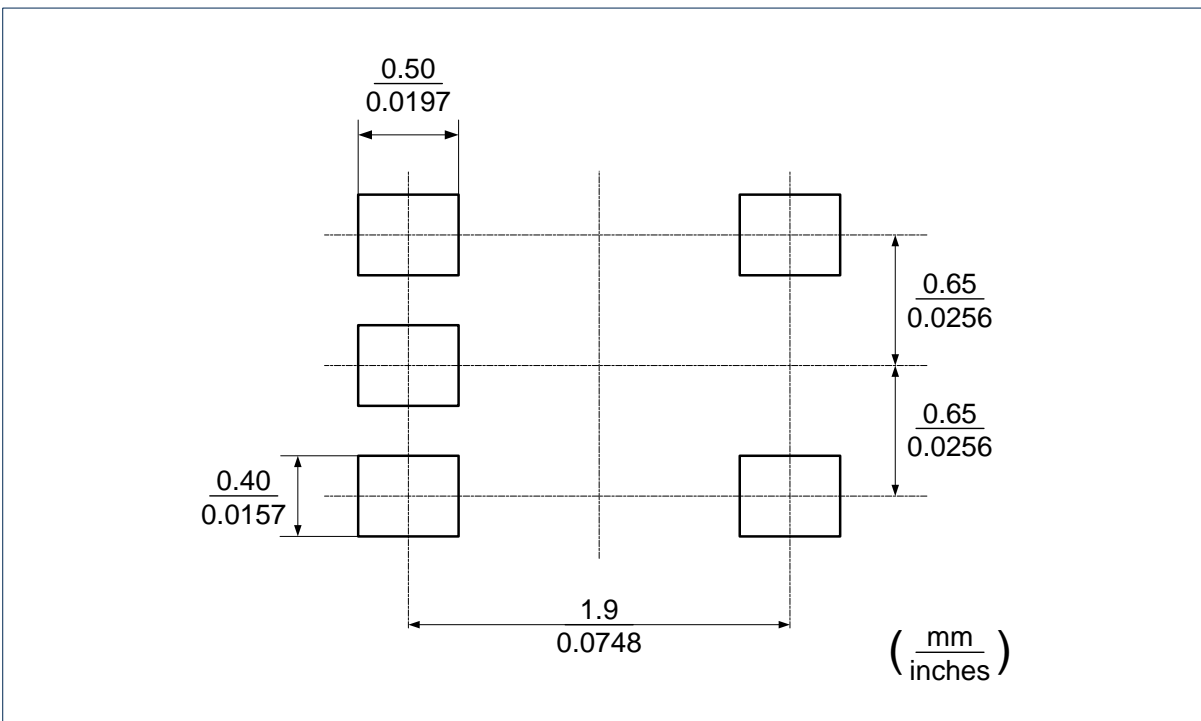

CAUTION: These devices are sensitive to electrostatic discharge; follow proper IC Handling Procedures.  
 Linearin and designs are registered trademarks of Linearin Technology Corporation.  
 © Copyright Linearin Technology Corporation. All Rights Reserved.  
 All other trademarks mentioned are the property of their respective owners.

## Package Outlines (continued)

### DIMENSIONS, SOIC-8L

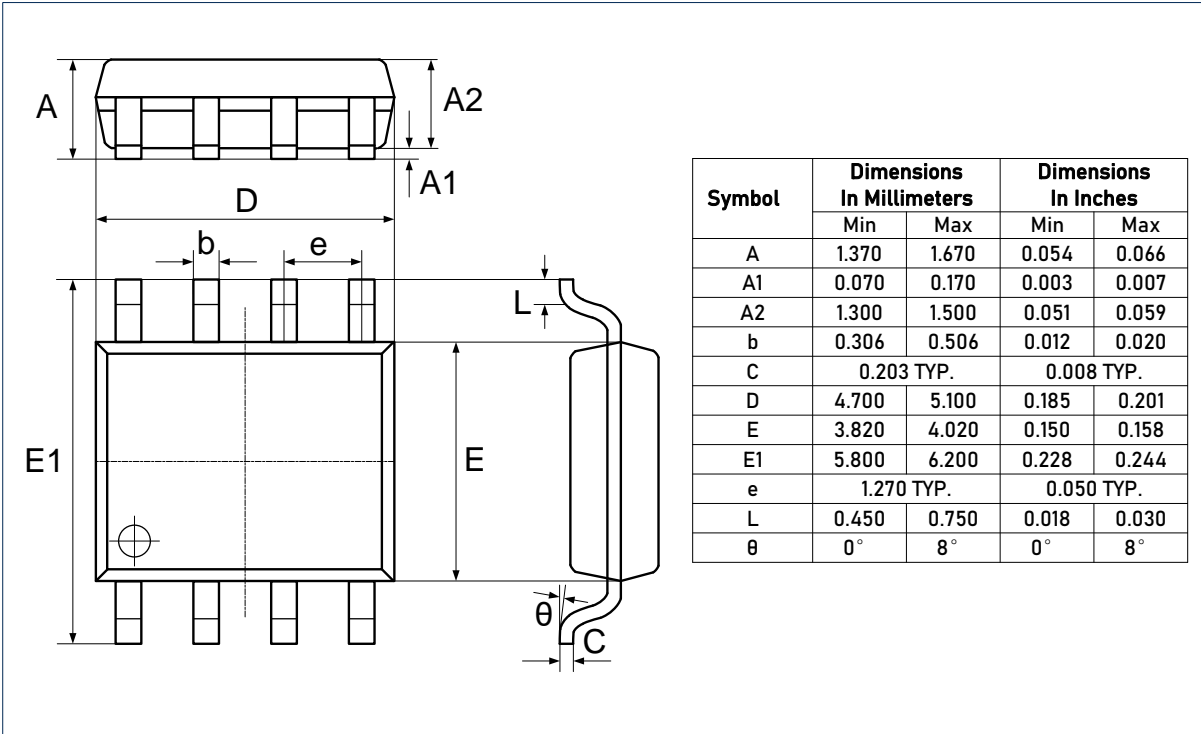

### RECOMMENDED SOLDERING FOOTPRINT, SOIC-8L

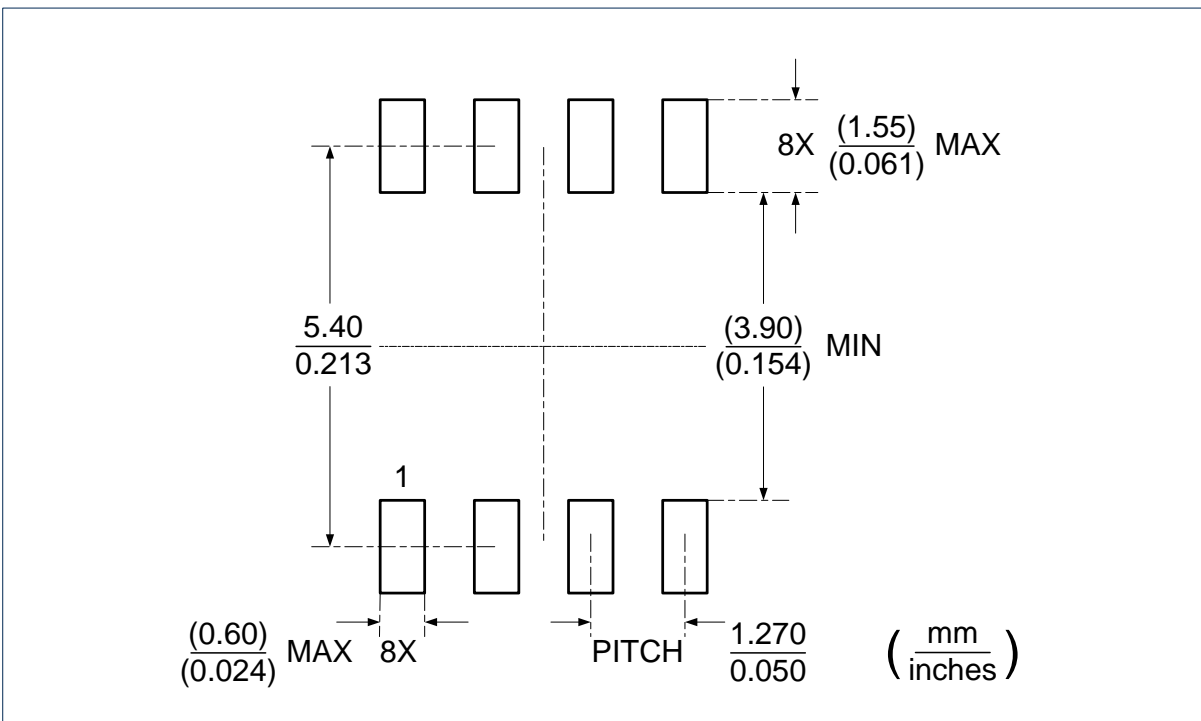

CAUTION: These devices are sensitive to electrostatic discharge; follow proper IC Handling Procedures.  
 Linearin and designs are registered trademarks of Linearin Technology Corporation.  
 © Copyright Linearin Technology Corporation. All Rights Reserved.  
 All other trademarks mentioned are the property of their respective owners.

## Package Outlines (continued)

### DIMENSIONS, MSOP-8L

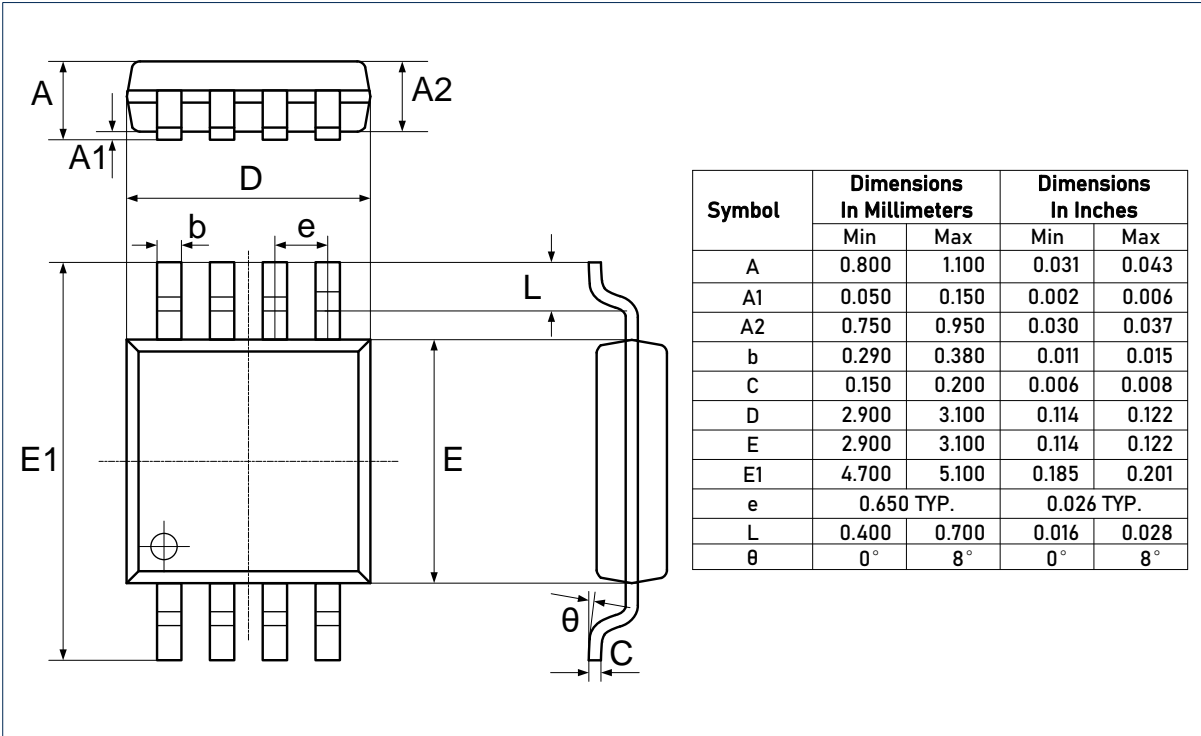

### RECOMMENDED SOLDERING FOOTPRINT, MSOP-8L

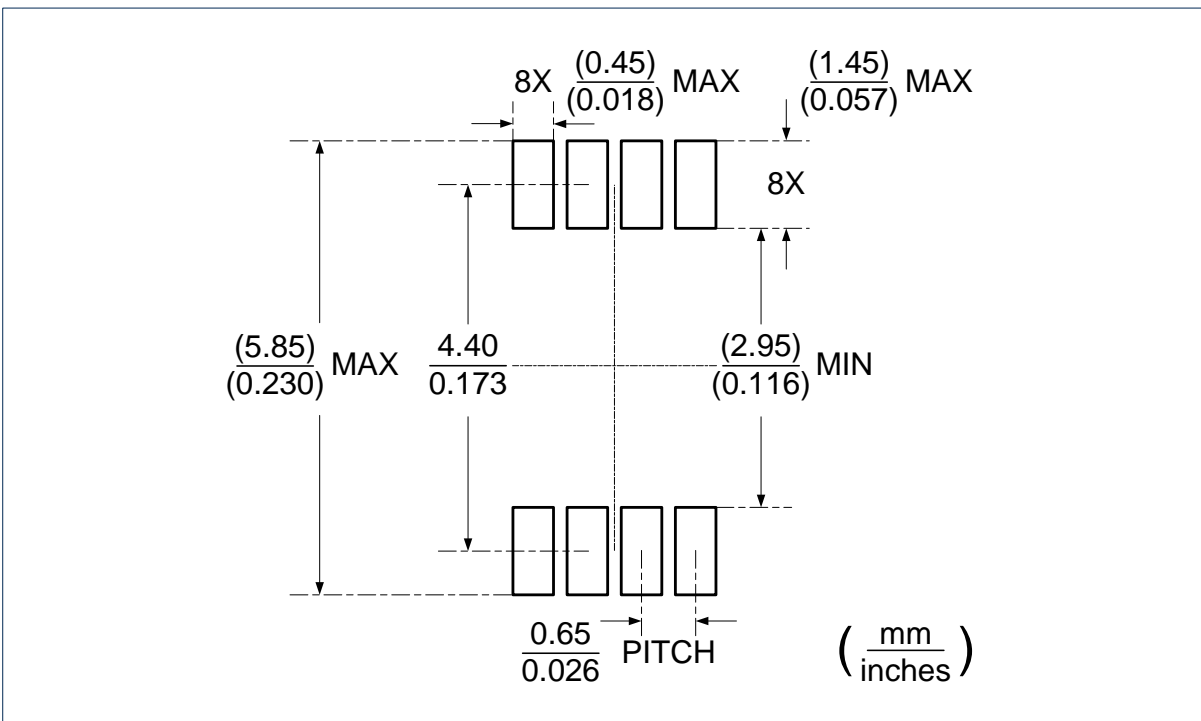

CAUTION: These devices are sensitive to electrostatic discharge; follow proper IC Handling Procedures.  
 Linearin and designs are registered trademarks of Linearin Technology Corporation.  
 © Copyright Linearin Technology Corporation. All Rights Reserved.  
 All other trademarks mentioned are the property of their respective owners.



## Package Outlines (continued)

### DIMENSIONS, DFN2x2-8L

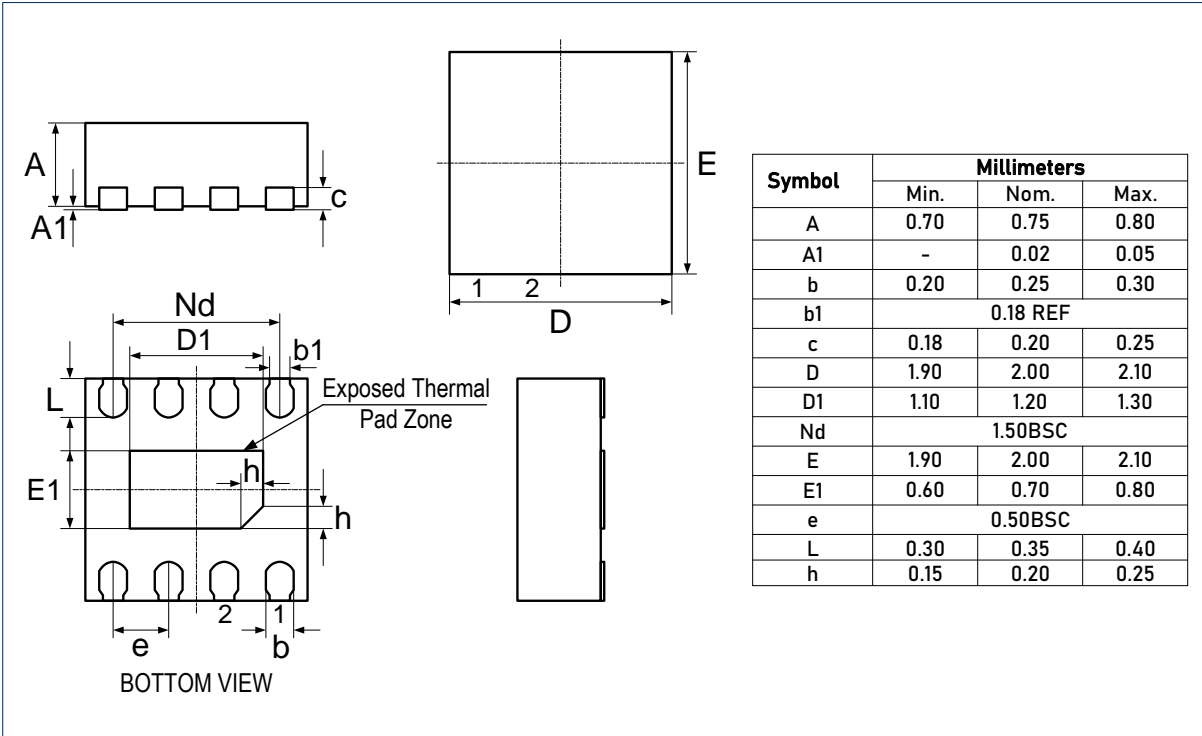

### RECOMMENDED SOLDERING FOOTPRINT, DFN2x2-8L

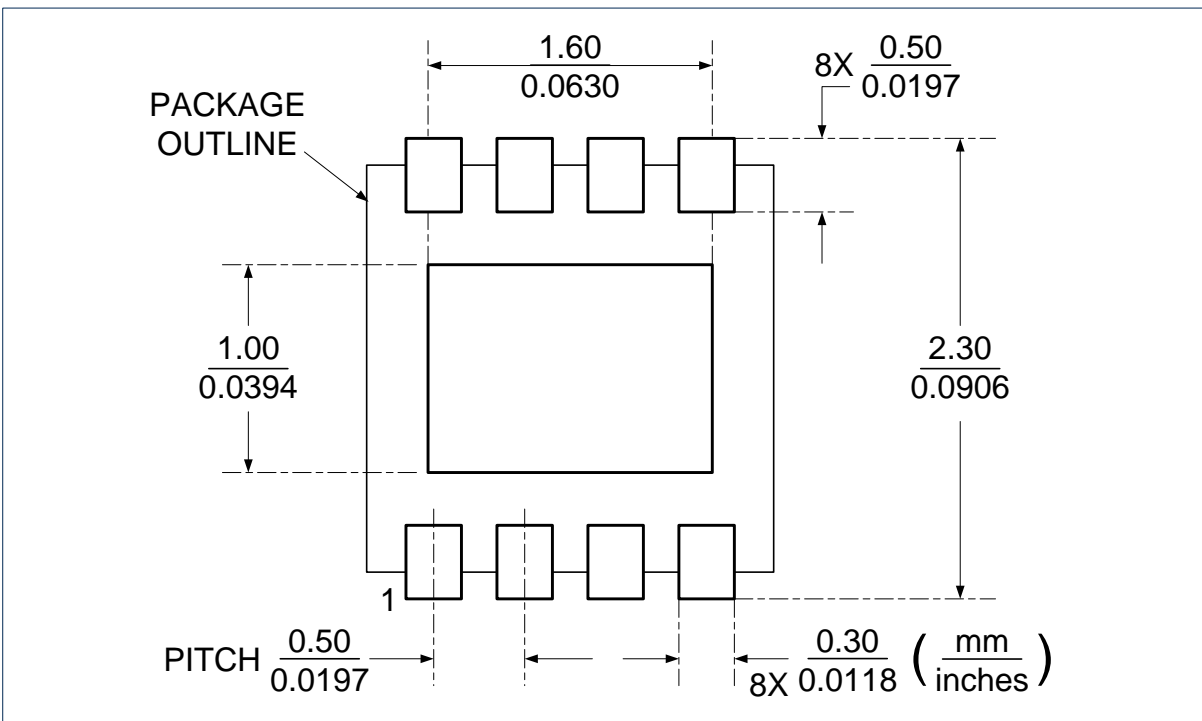

CAUTION: These devices are sensitive to electrostatic discharge; follow proper IC Handling Procedures.  
 Linearin and designs are registered trademarks of Linearin Technology Corporation.  
 © Copyright Linearin Technology Corporation. All Rights Reserved.  
 All other trademarks mentioned are the property of their respective owners.

## Package Outlines (continued)

### DIMENSIONS, SOIC-14L

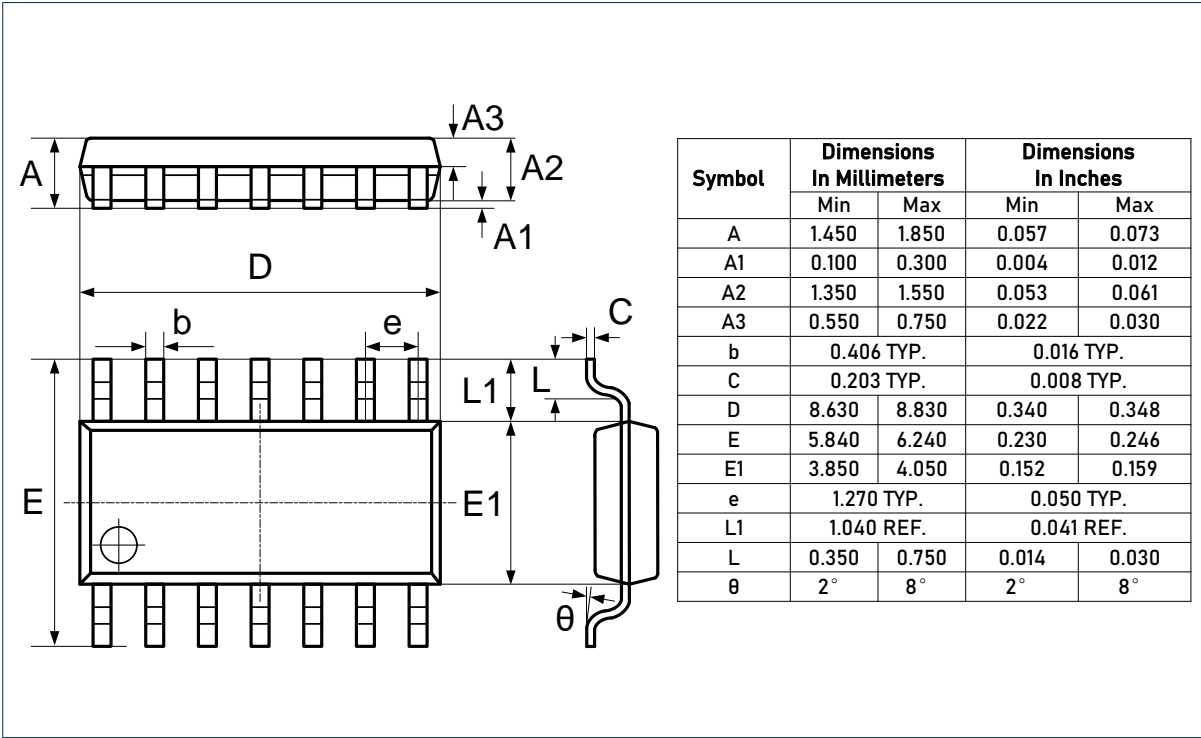

### RECOMMENDED SOLDERING FOOTPRINT, SO-14

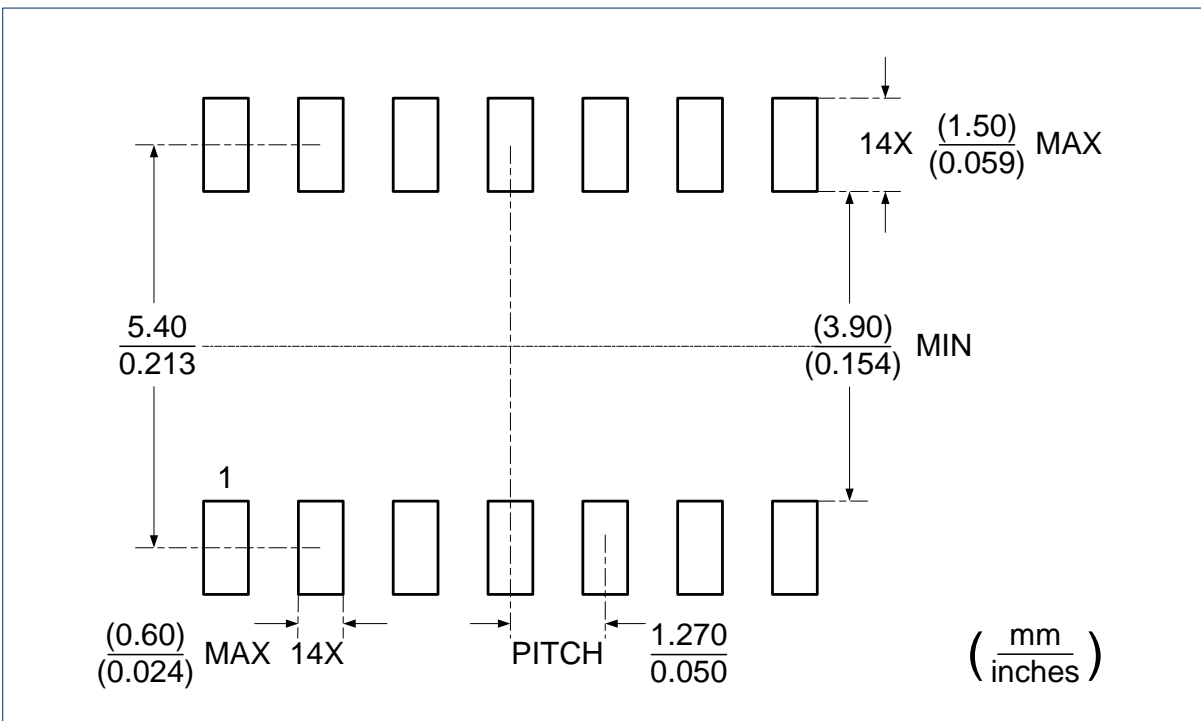

CAUTION: These devices are sensitive to electrostatic discharge; follow proper IC Handling Procedures.  
 Linearin and designs are registered trademarks of Linearin Technology Corporation.  
 © Copyright Linearin Technology Corporation. All Rights Reserved.  
 All other trademarks mentioned are the property of their respective owners.

## Package Outlines (continued)

### DIMENSIONS, QFN3x3-16L

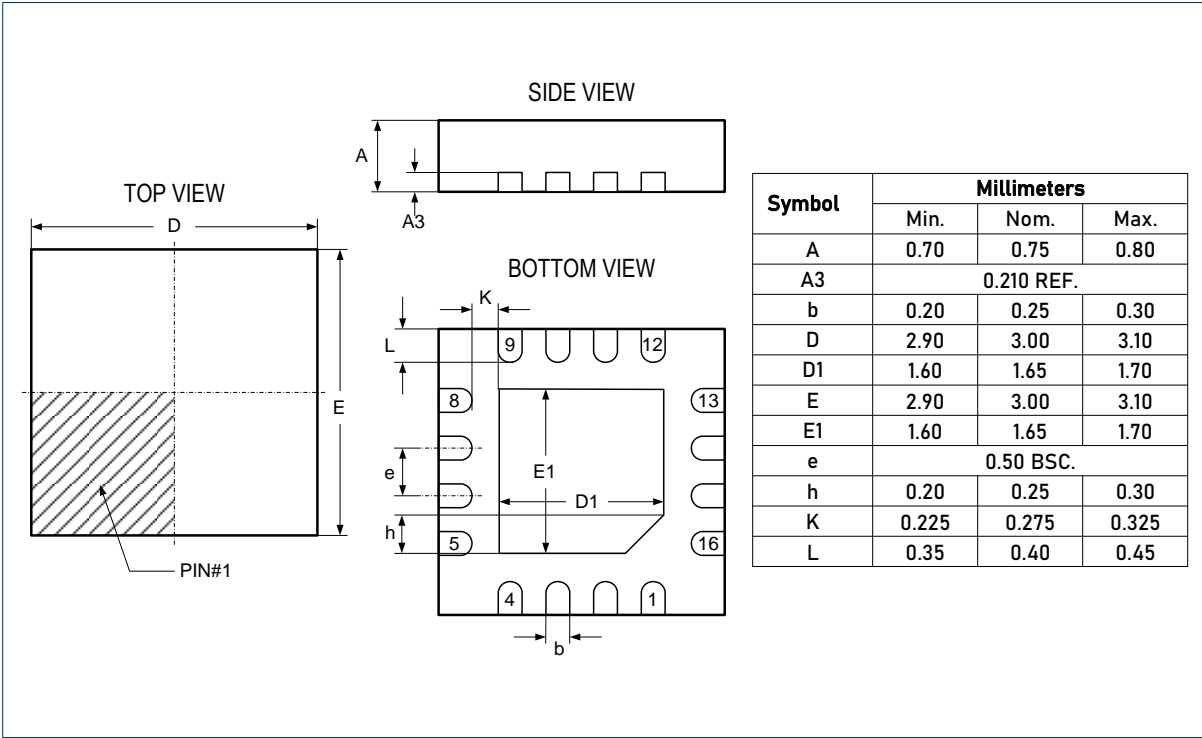

### RECOMMENDED SOLDERING FOOTPRINT, QFN3x3-16L

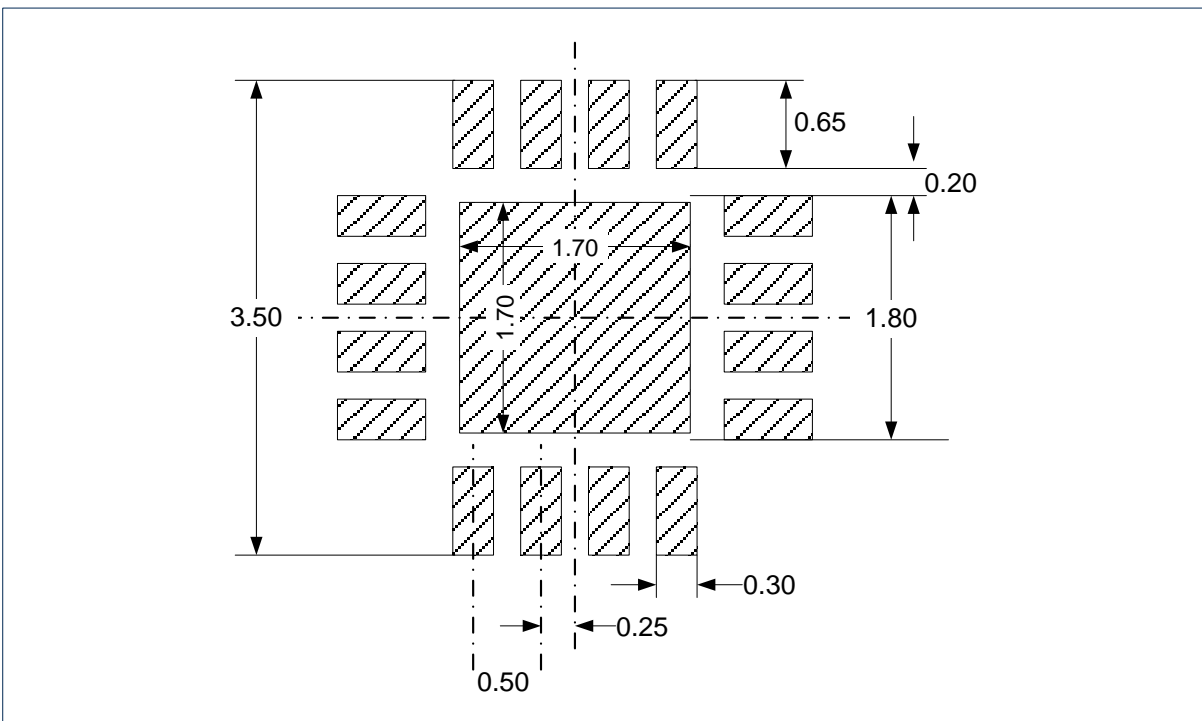

CAUTION: These devices are sensitive to electrostatic discharge; follow proper IC Handling Procedures.  
Linearin and designs are registered trademarks of Linearin Technology Corporation.  
© Copyright Linearin Technology Corporation. All Rights Reserved.  
All other trademarks mentioned are the property of their respective owners.

## Package Outlines (continued)

### DIMENSIONS, TSSOP-14L

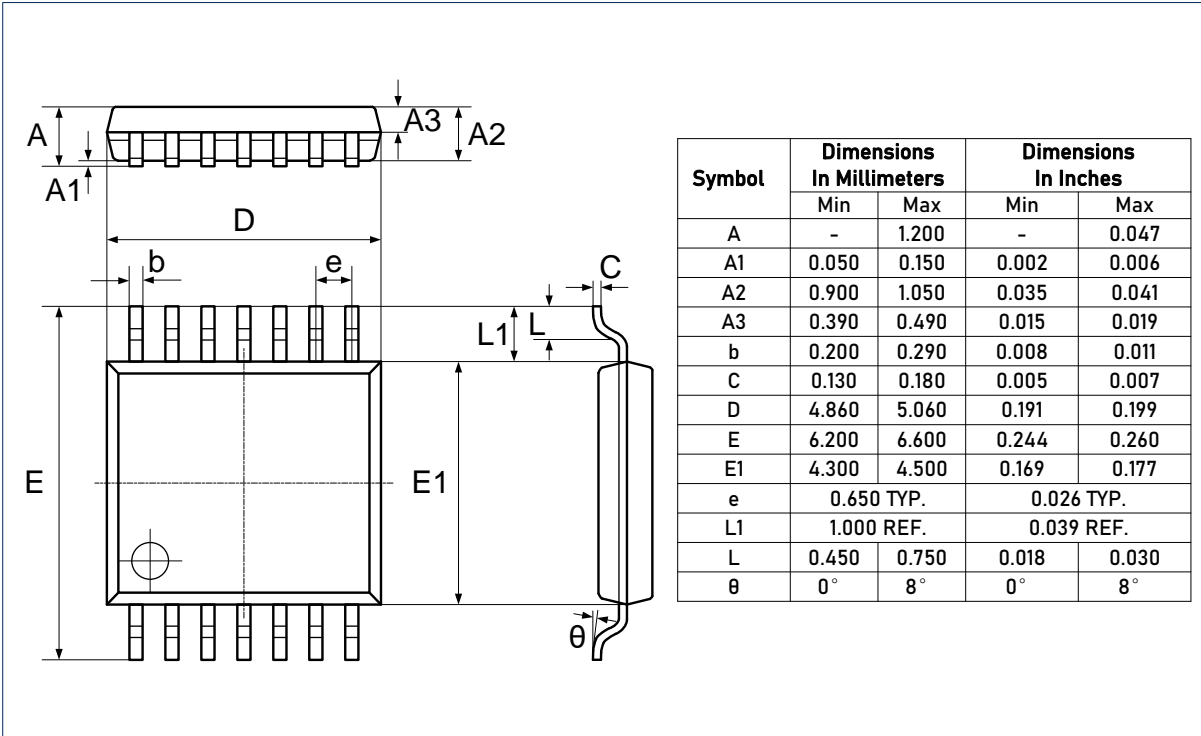

### RECOMMENDED SOLDERING FOOTPRINT, TSSOP-14L

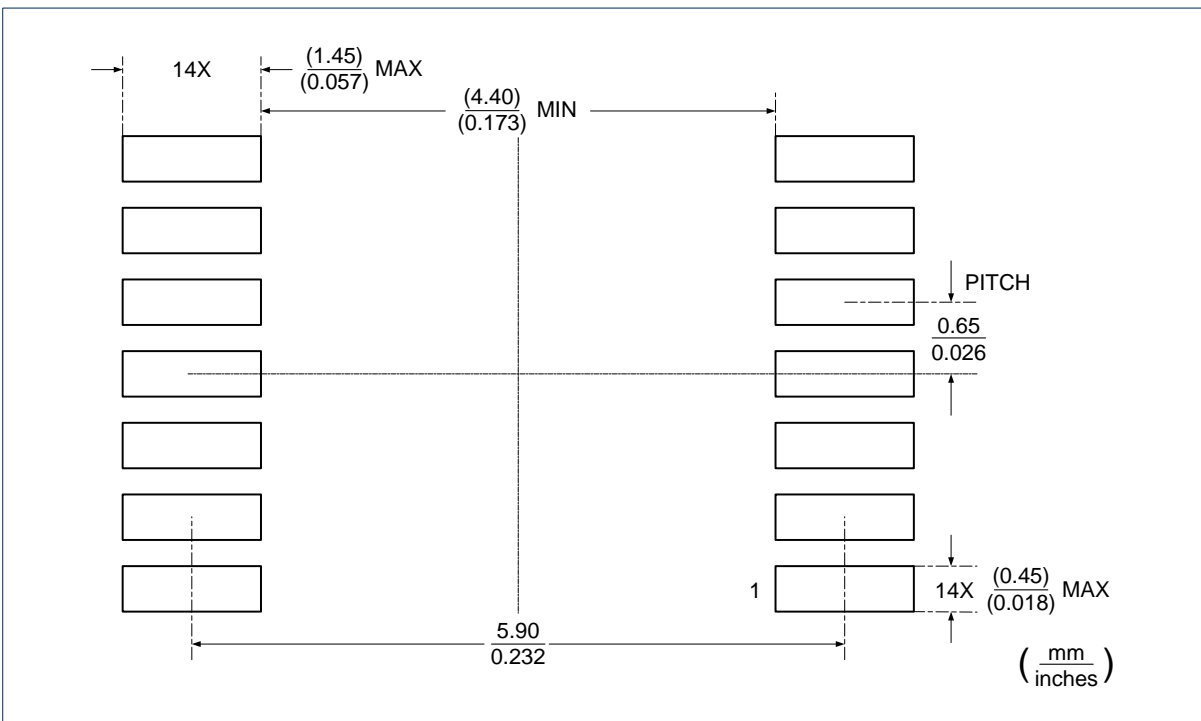

CAUTION: These devices are sensitive to electrostatic discharge; follow proper IC Handling Procedures.  
Linearin and designs are registered trademarks of Linearin Technology Corporation.  
© Copyright Linearin Technology Corporation. All Rights Reserved.  
All other trademarks mentioned are the property of their respective owners.

## IMPORTANT NOTICE

---

Linearin is a global fabless semiconductor company specializing in advanced high-performance high-quality analog/mixed-signal IC products and sensor solutions. The company is devoted to the innovation of high performance, analog-intensive sensor front-end products and modular sensor solutions, applied in multi-market of medical & wearable devices, smart home, sensing of IoT, and intelligent industrial & smart factory (industrie 4.0). Linearin's product families include widely-used standard catalog products, solution-based application specific standard products (ASSPs) and sensor modules that help customers achieve faster time-to-market products. Go to <http://www.linearin.com> for a complete list of Linearin product families.

For additional product information, or full datasheet, please contact with the Linearin's Sales Department or Representatives.